

APPLICATIONS: Provides access to drawers or trays installed at shoulder height and above in applications such as store fixtures, and garage or warehouse storage.

Aluminum Track
Drawers up to 40" wide
Up to 140-lb. [65kg] load capacity

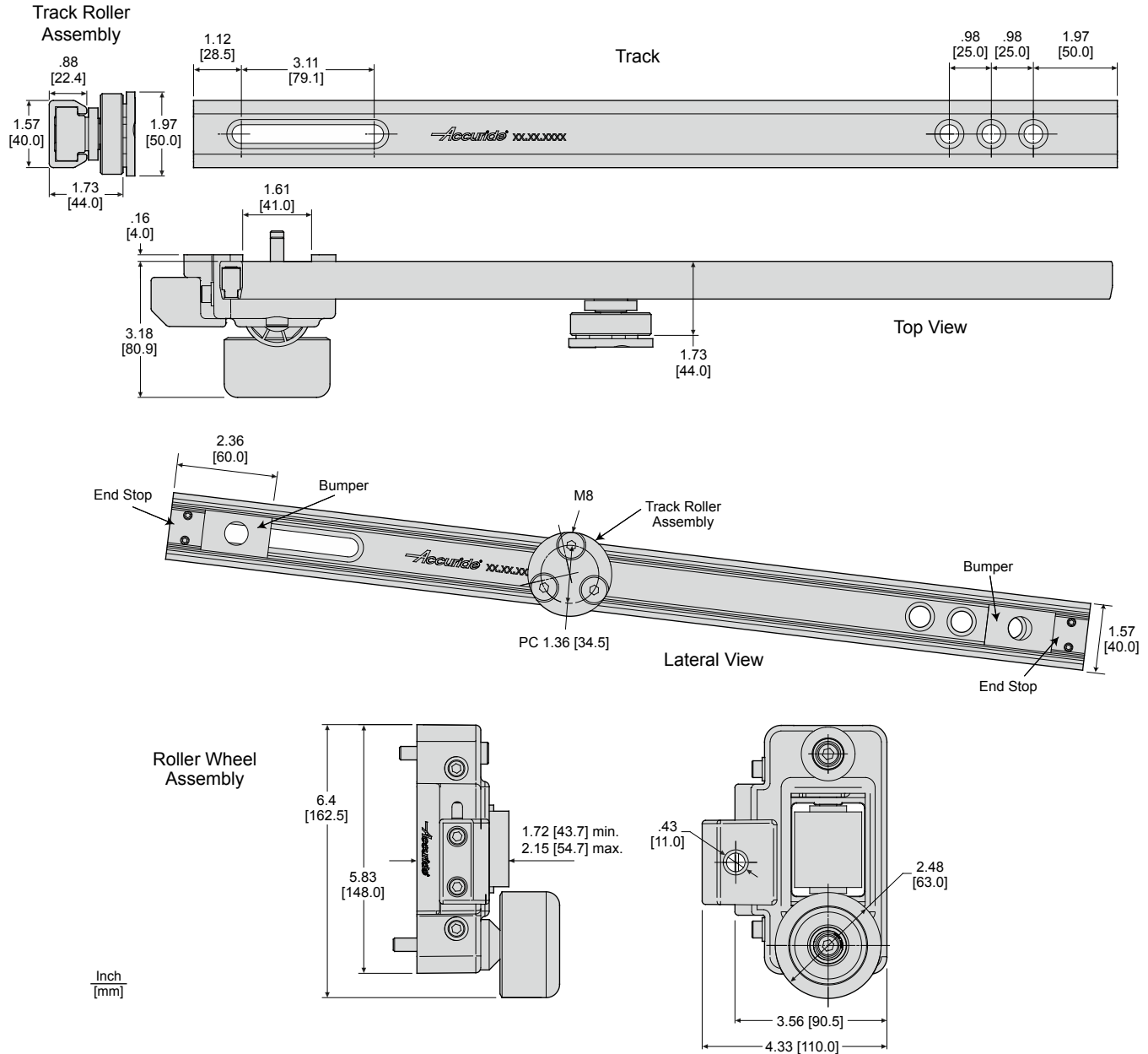

Track: Aluminum

Track Lengths: 24" [600mm] and 40" [1000mm]

Side Space: 1.73" [44mm] (track and track roller)

Roller Wheel Assembly
 Height: 6.4" [162.5mm]
 Width: 3.18" [80.9mm]
 Depth: 4.33" [110.0mm]

Load rating: Up to 140 lbs. [65kg]

Features: Tilt angle is set by installer; track may be cut down to fit application.

Compatible with CBHand-2 Locking Handle Kit (adds lock-in capability)

Part #	Track Length	Weight
AL4190-24	24" [600mm]	5.6 lbs. [2.53kg]
AL4190-40	40" [1000mm]	7.0 lbs. [3.20kg]

Installation Instructions

Note: Be sure to provide adequate vertical clearance to allow for drawer movement.

The tilt angle of the drawer or tray is altered by:

- The angle of the track
- Position of the bumper stops.

The front of the drawer rests on the wheel of the roller wheel assembly. The rear of the drawer is affixed to the track roller assembly (Figure 1).

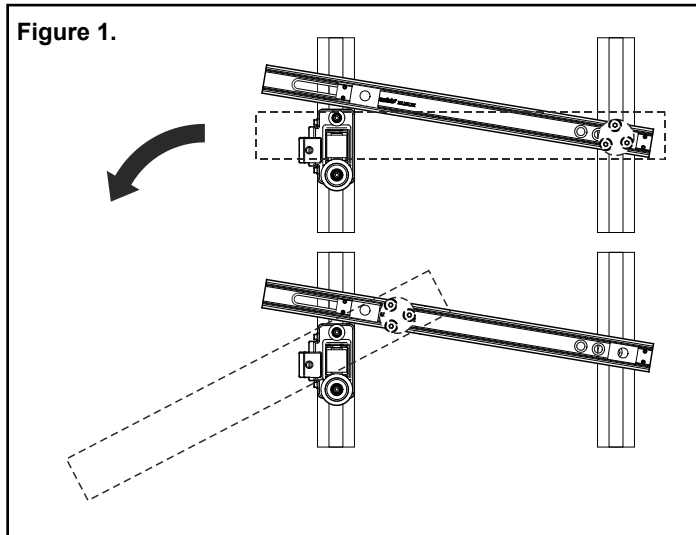

1. **Metal Cabinet Installations:** Install roller wheel assembly using the M8 hardware provided. (Figure 2) If using strut channel, use M8 strut nuts to ease adjustment (strut hardware not provided).

Wood Cabinet Installations: Use a fastener such as M8 cap nut bolts (not included) of sufficient length to go through the assembly and cabinet wall.

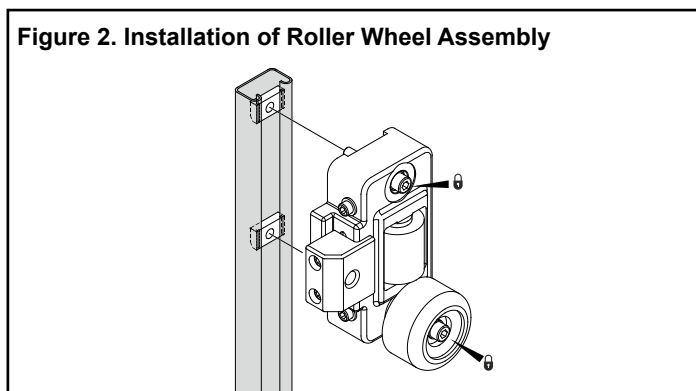

2. Remove the track roller assembly, the rear bumper stop, and end stop (Figure 3).

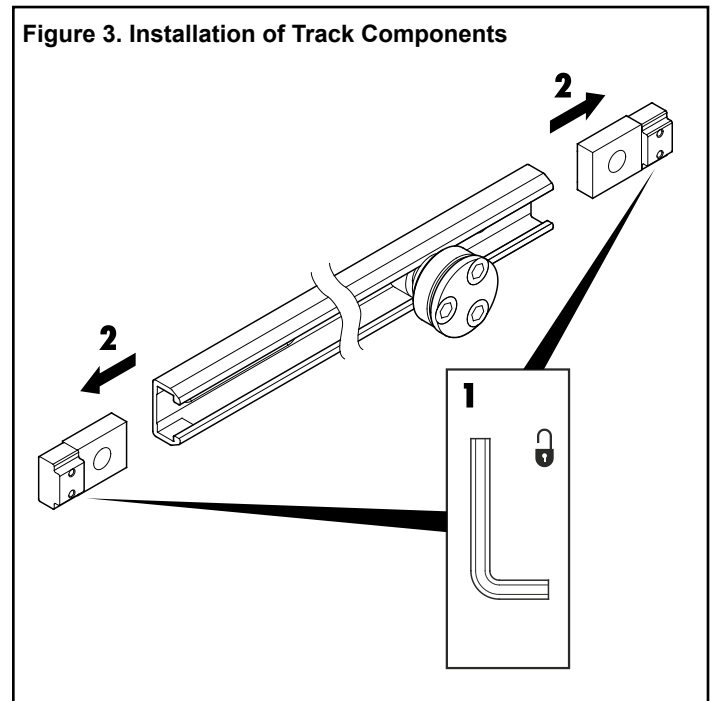

3. Install the track using M8 or 5/16" flat head bolts or machine screws (not included) at the front and rear of the track. Be sure the fasteners are flush with the track and do not interfere with track roller movement.

Note: The long slot at the front and holes at the rear of the track allow for setting the track angle (Figure 4). If cutting track down to a custom length, remove track from the rear so that the adjustment slot at the front remains in place. Re-drill and countersink new mounting holes as needed to affix the track.

A good starting point is to set the track at a 15° angle, although this varies based on the application.

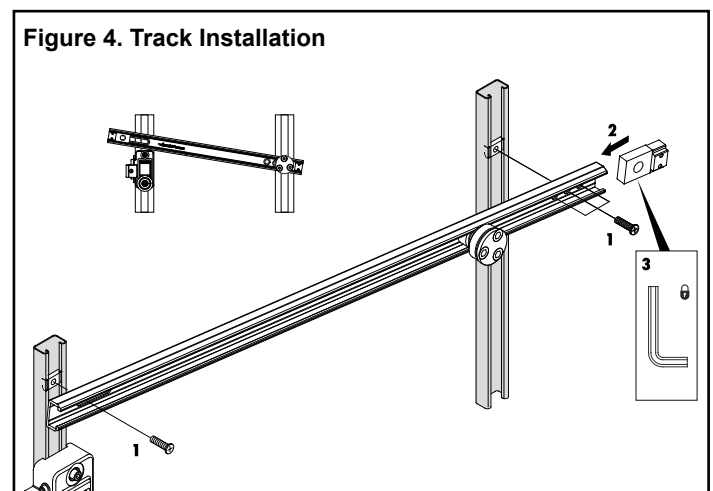

4. Reinstall track roller, rear bumper and end stop.

Drawer Preparation

5. Rest the drawer on the front wheels of the Roller Wheel assemblies, aligning the drawer front flush to the roller wheel assembly. Raise the rear of the drawer to a level position and mark the locations of the track roller (Figure 5).

Note: The track roller position can be altered depending on application requirements.

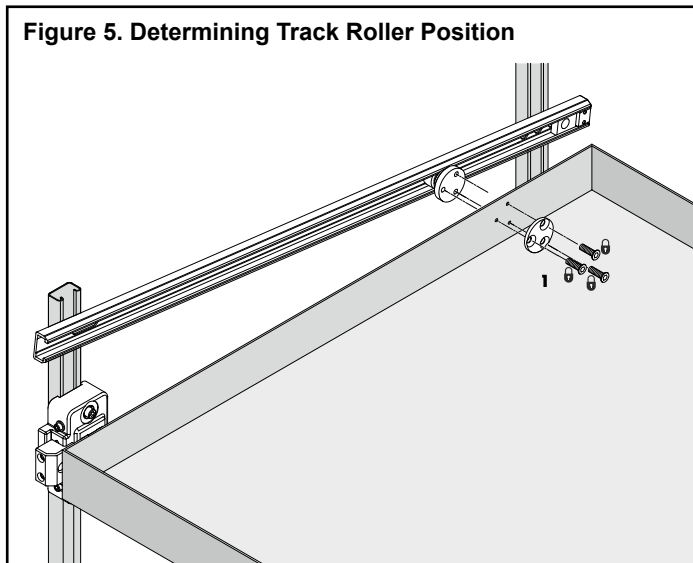

6. Using a 3/8" or 9mm drill bit, drill holes 120° apart on a circle with a diameter of 1.36" [34.5mm] (Figure 6).

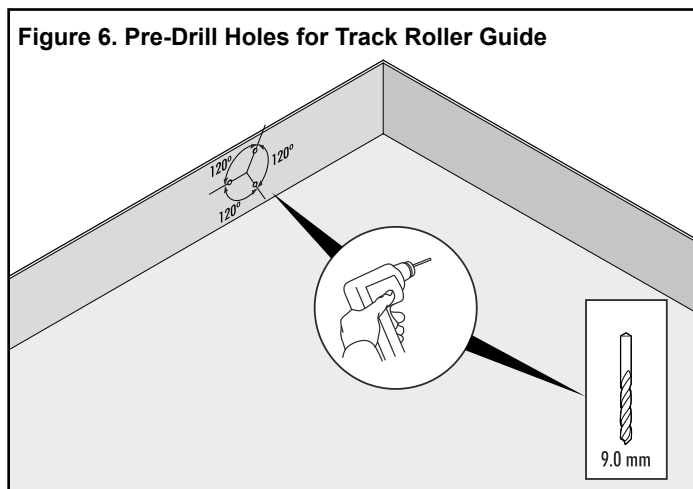

7. Remove the track roller guide from the track. Remove Track Roller Guide fasteners to separate the plate from the assembly. Place the plate on the inside of the drawer and re-insert M8 flat head screws as shown in Figure 7.

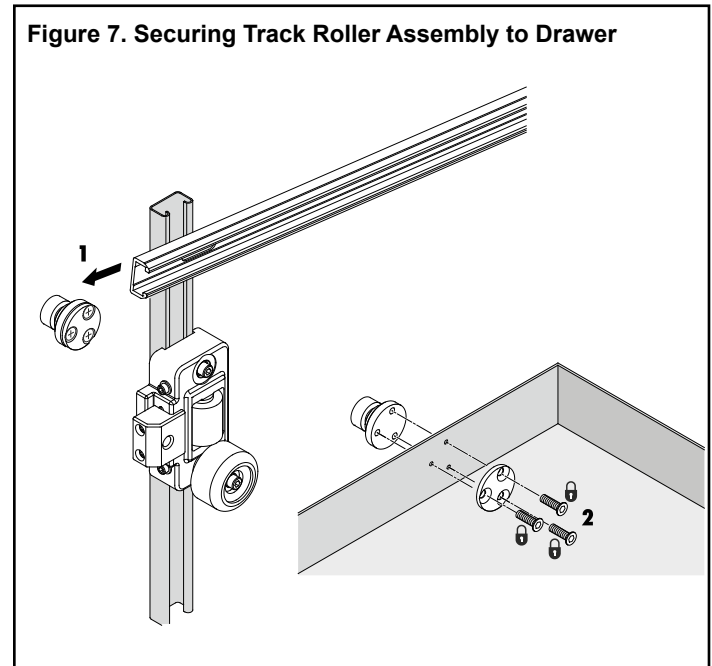

8. Insert the drawer (Figure 8). Insert the front bumper stop and end stop and tighten set screws.

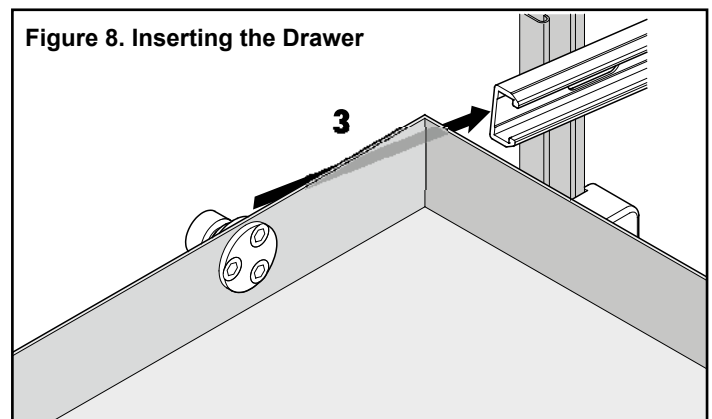

Drawer Adjustment

- Determine travel and angle by adjusting the position of the front bumper stops (Figure 9). Tighten end stop set screws after adjustments are complete. Be mindful of the angle of the tilt and the intended contents, which may need to be secured.

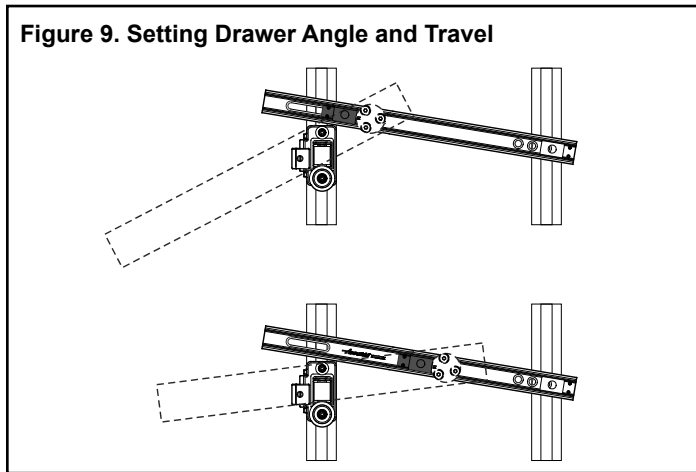

- To adjust the side stabilizer roller, use the adjustment screws located at the top and bottom of the front face of the roller wheel assembly (Figure 10).

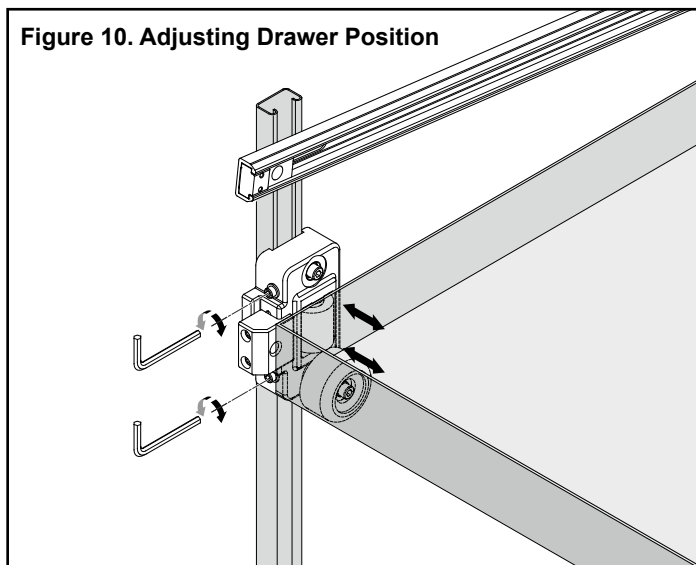

Model AL4190 is sold as a kit, which includes:

- 2X - aluminum tracks, cover caps, roller wheel assemblies, and track roller guides
- 4X - bumper stops and end stops

Track fasteners are not included. Through bolts are recommended for track installation to safely support drawers in wood cabinetry.

Ordering

Kits are available in two track lengths: 24" [600mm] and 40" [1000mm].

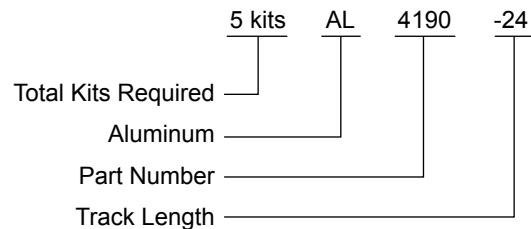

Accessories

Compatible with CBHand-2 Locking Handle Kit, a double handle with a central push button that adds a lock-in feature.

Specifications

- Track: Aluminum
- Track Roller Guides: Aluminum
- Roller Wheel Assemblies: Polymer and zinc-plated steel components.

RoHS compliant

NOTE: Specifications, materials, prices, terms, and delivery are subject to change without notice.



ACCURIDE INTERNATIONAL INC.

12311 Shoemaker Avenue
Santa Fe Springs, CA 90670

TEL (562) 903-0200

FAX (562) 903-0208

www accuride.com

Manufacturing, Engineering, and Sales

United States • Germany • Japan • Mexico • United Kingdom • China

Copyright © 2014 Accuride International Inc. 3700 (9561)1265-MK980-N-0914